

Ekonomik Sürme Sistem

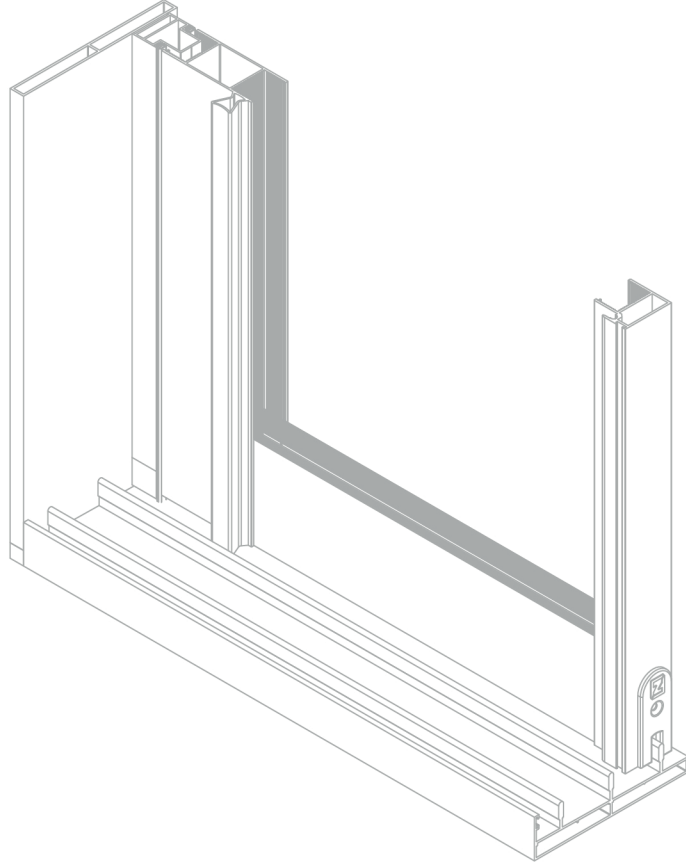

EKONOMİK SÜRME SİSTEM	EKONOMİK SÜRME SİSTEM	V.E.S.	V.E.S.	101
	<ul style="list-style-type: none">✓ Kasa; 3 Raylı ve 5 raylı✓ Cam Özelliği; 8 mm, 10 mm tek cam ve 20 mm ıscam✓ Max. kanat ağırlığı : 120 kg		SİSTEM	PR NO



ÜÇLÜ YAN KASA PROFİL
V.ES.101
1.065 kg/mt

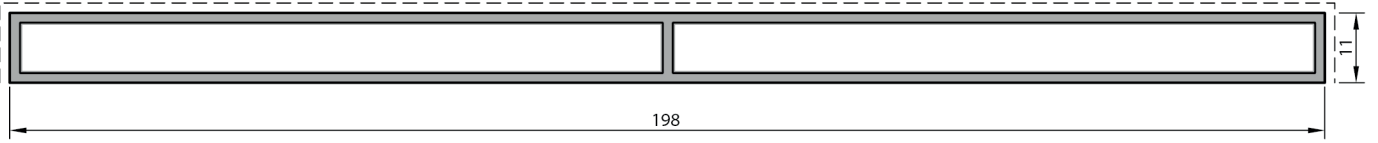

BEŞLİ YAN KASA PROFİL
V.ES.102
1.703 kg/mt

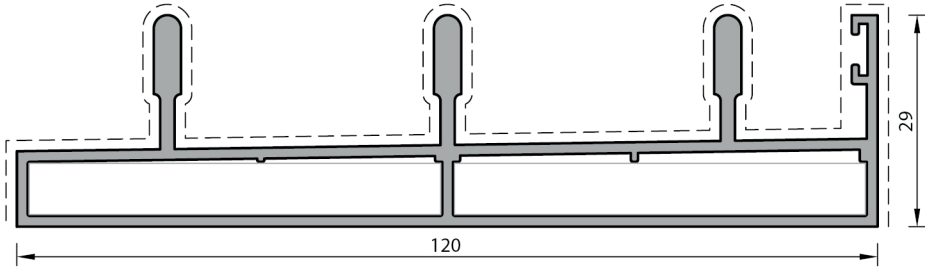

ÜÇ RAYLI PROFİL
V.ES.100
1.624 kg/mt

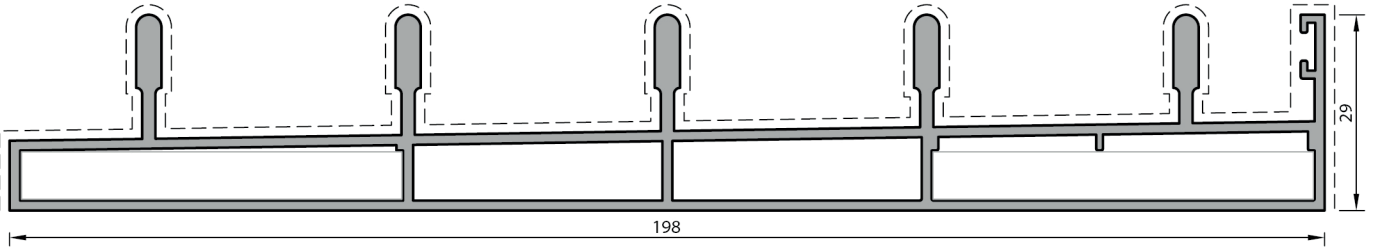

BEŞ RAYLI PROFİL
V.ES.110
2.625 kg/mt

* Profil ağırlıkları teoriktir. Ağırlık olarak teslimde yapılan tartım geçerlidir.

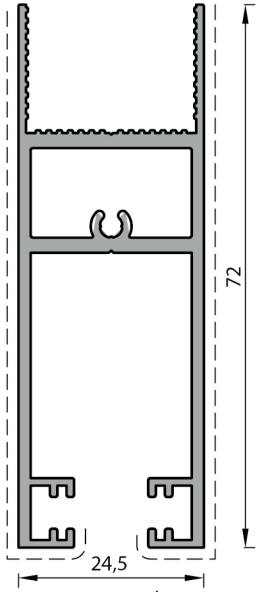

BAZA PROFİL
V.ES.105
0.935 kg/mt

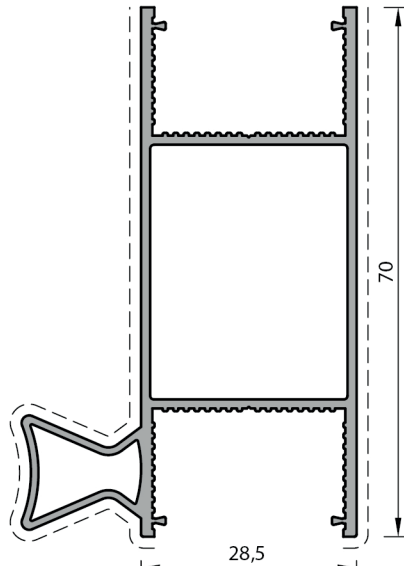

DÜŞEY KANAT PROFİL
V.ES.107
0.870 kg/mt

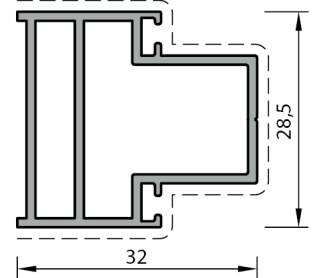

KİLİT KARŞILIK PROFİL
V.ES.106
0.485 kg/mt

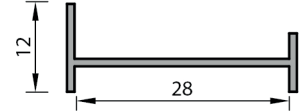

KENET DESTEK PROFİL
V.ES.112
0.130 kg/mt

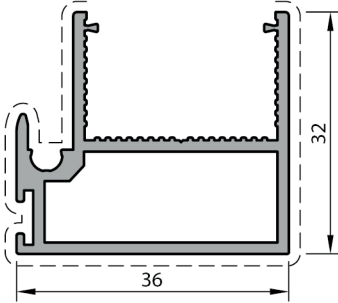

KENET PROFİL
V.ES.109
0.606 kg/mt

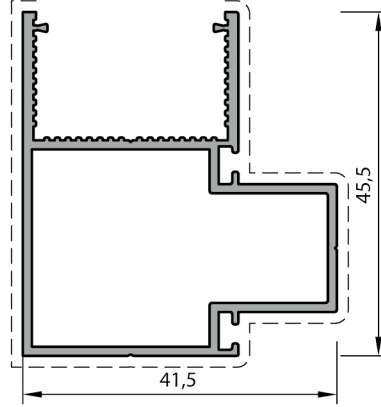

90° KÖŞE PROFİL
V.ES.111
0.625 kg/mt

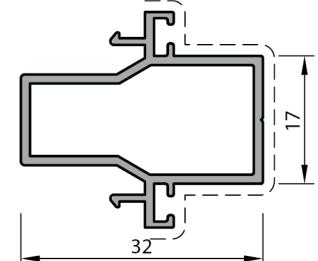

KANAT BİRLEŞİM PROFİLİ
V.ES.108
0.375 kg/mt

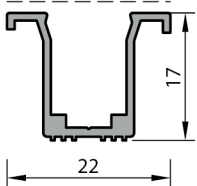

10 MM CAM ÇITA PROFİL
V.ES.103
0.174 kg/mt

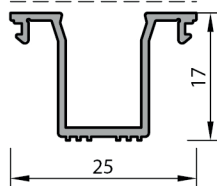

10 MM CAM ÇITA PROFİL
V.ES.104
0.176 kg/mt

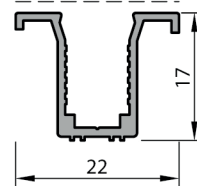



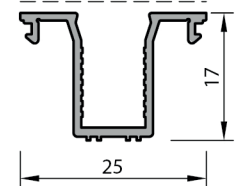



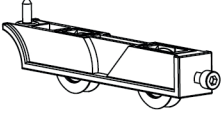

8 MM CAM ÇITA PROFİL
V.ES.116
0.169 kg/mt

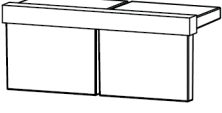
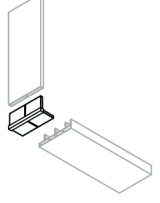
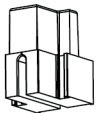
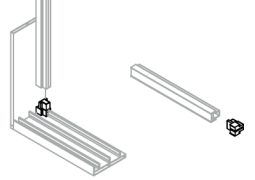
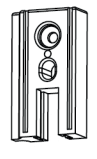
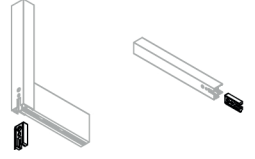
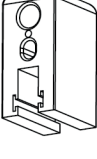
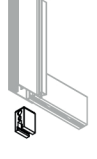
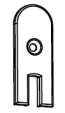
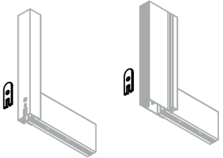

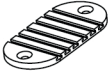
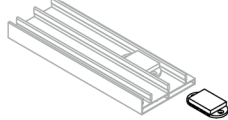
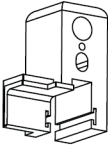
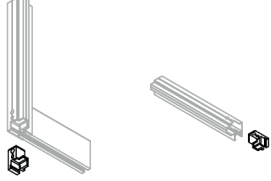
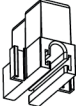
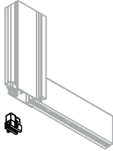
8 MM CAM ÇITA PROFİL
V.ES.115
0.178 kg/mt

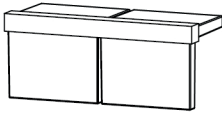
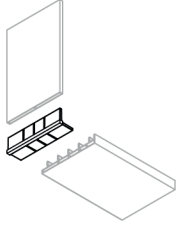
* Profil ağırlıkları teoriktir. Ağırlık olarak teslimde yapılan tartım geçerlidir.

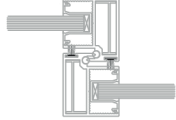
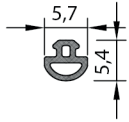
KOD	ŞEKİL	TANIM	PAKET METRAJİ	KULLANIM YERİ
ES-01		Ayarlı Rulman	2 Adet	
ES-02		3 lü Kasa Köşe	4 Adet	
ES-03		Kenar Kilitleme Takoza	4 Adet	
ES-04		Kenet Profil Takoza	8 Adet	
ES-05		Kol Profil Takoza	4 Adet	
ES-06		Kenet Kapak	12 Adet	

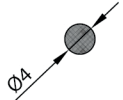
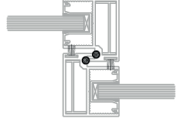
KOD	ŞEKİL	TANIM	PAKET METRAJİ	KULLANIM YERİ
ES-07		Tozluk	4 Adet	
ES-08		Köşe Dönüş Profil Takoza	2 Adet	
ES-09		Orta Adaptör Takoza	2 Adet	
ES-10		Havuz Kol Kilit Takimi	1 Takım	
ES-11		5 li Kasa Köşe Birleşim Takoza	4 Adet	
LS55520		Perdeli Fırça Fiteli	400 m/pk	
Z-93		Epdm Karşılık Baskı Fiteli	19 gr/m 12 kg - 630 m	
W55.511		Epdm Kenet Fiteli	16 gr/m 10 kg - 609 m	

3 ray

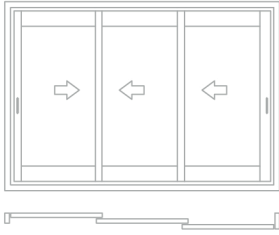

3 ray

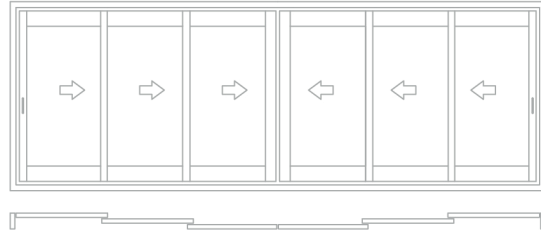

5 ray

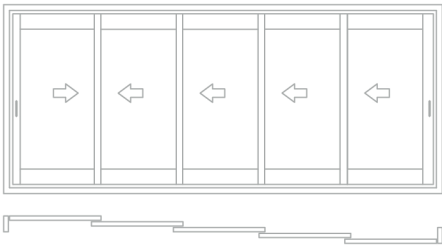

5 ray



3-5 ray

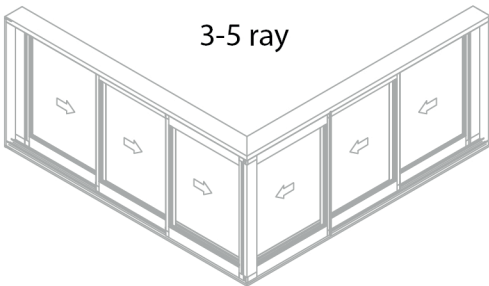

3-5 ray

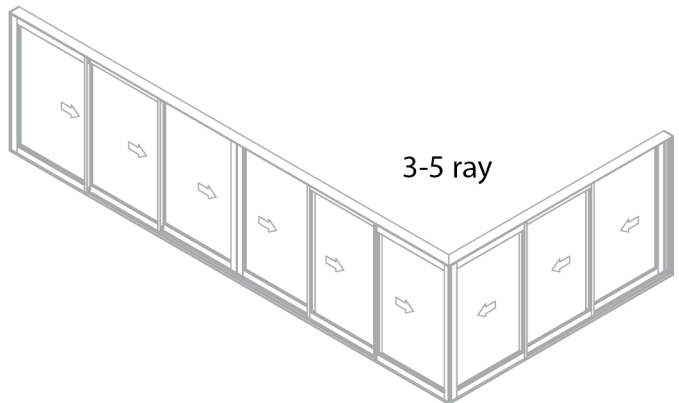

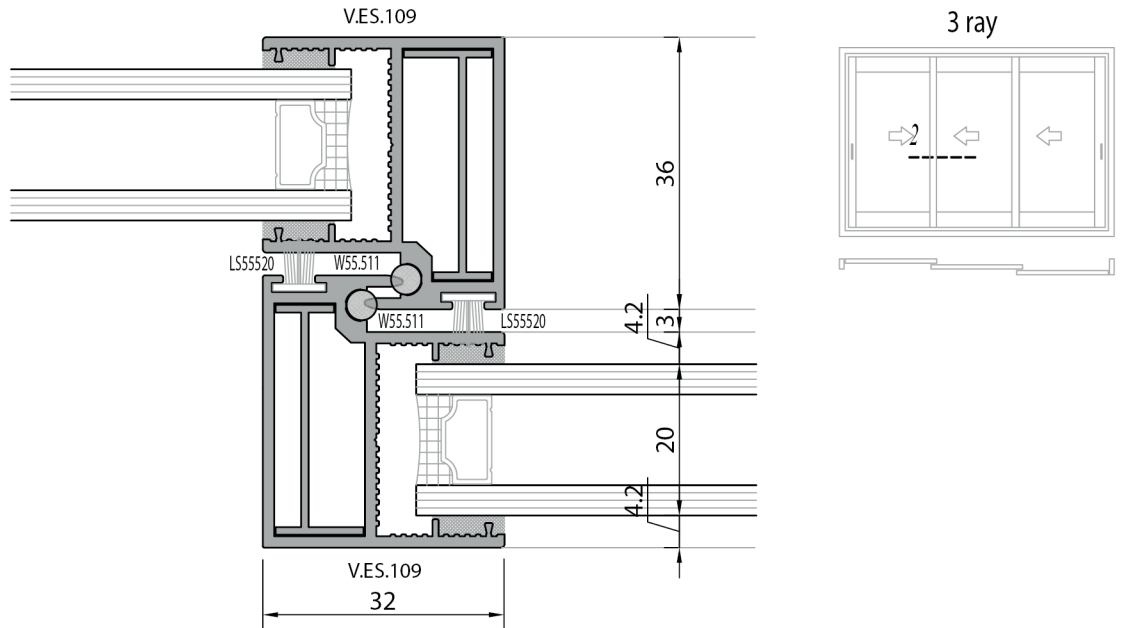
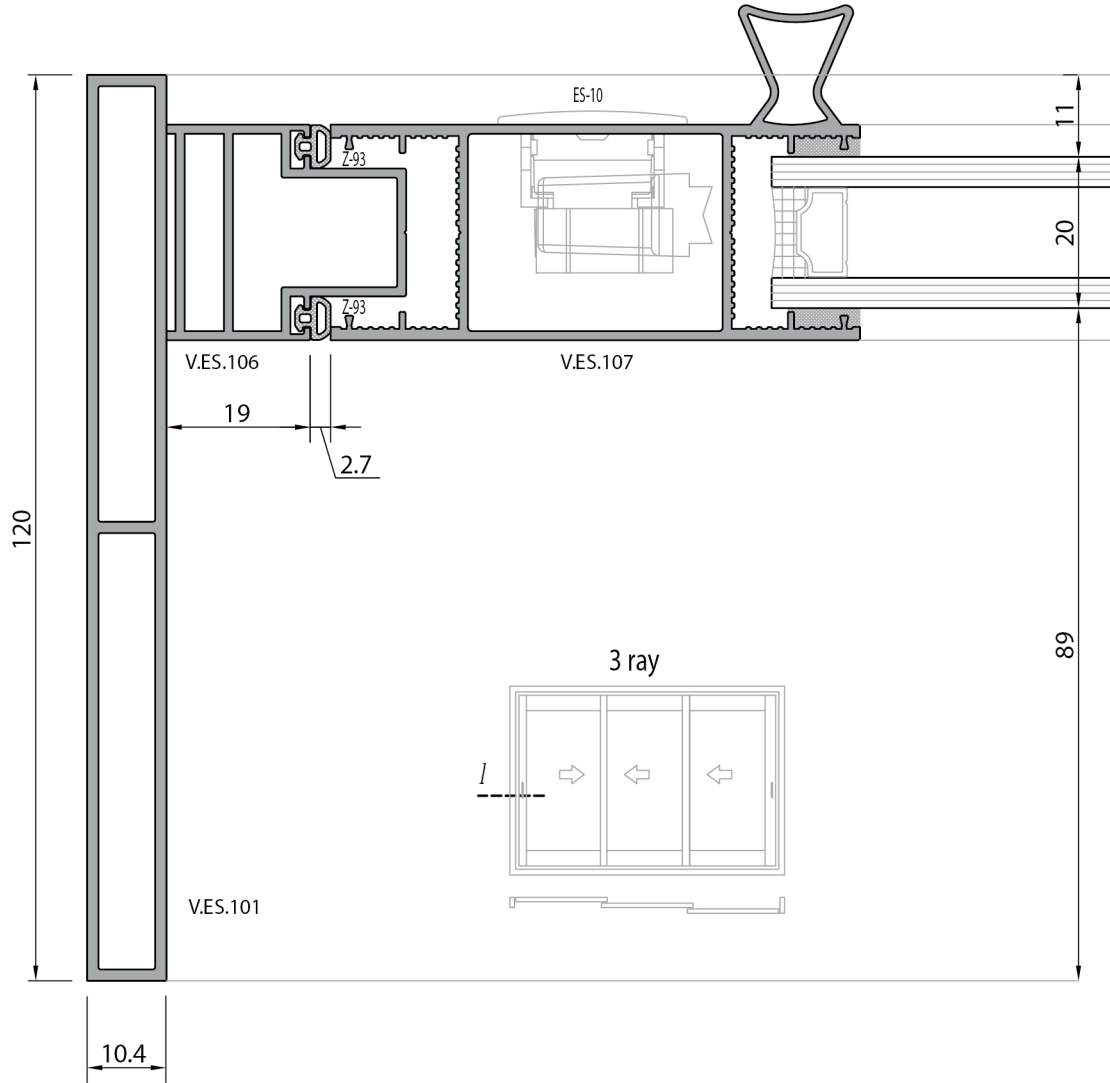

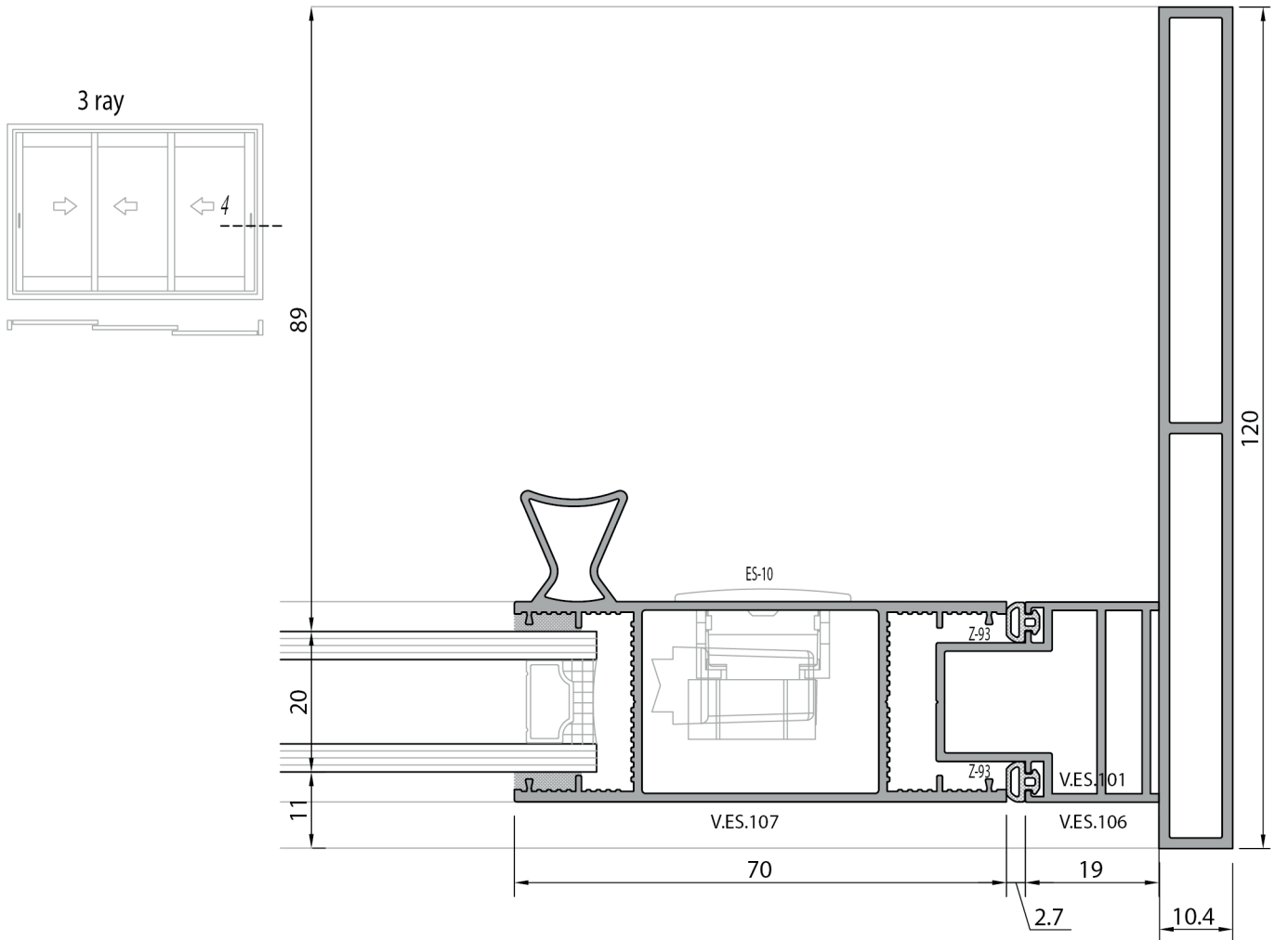
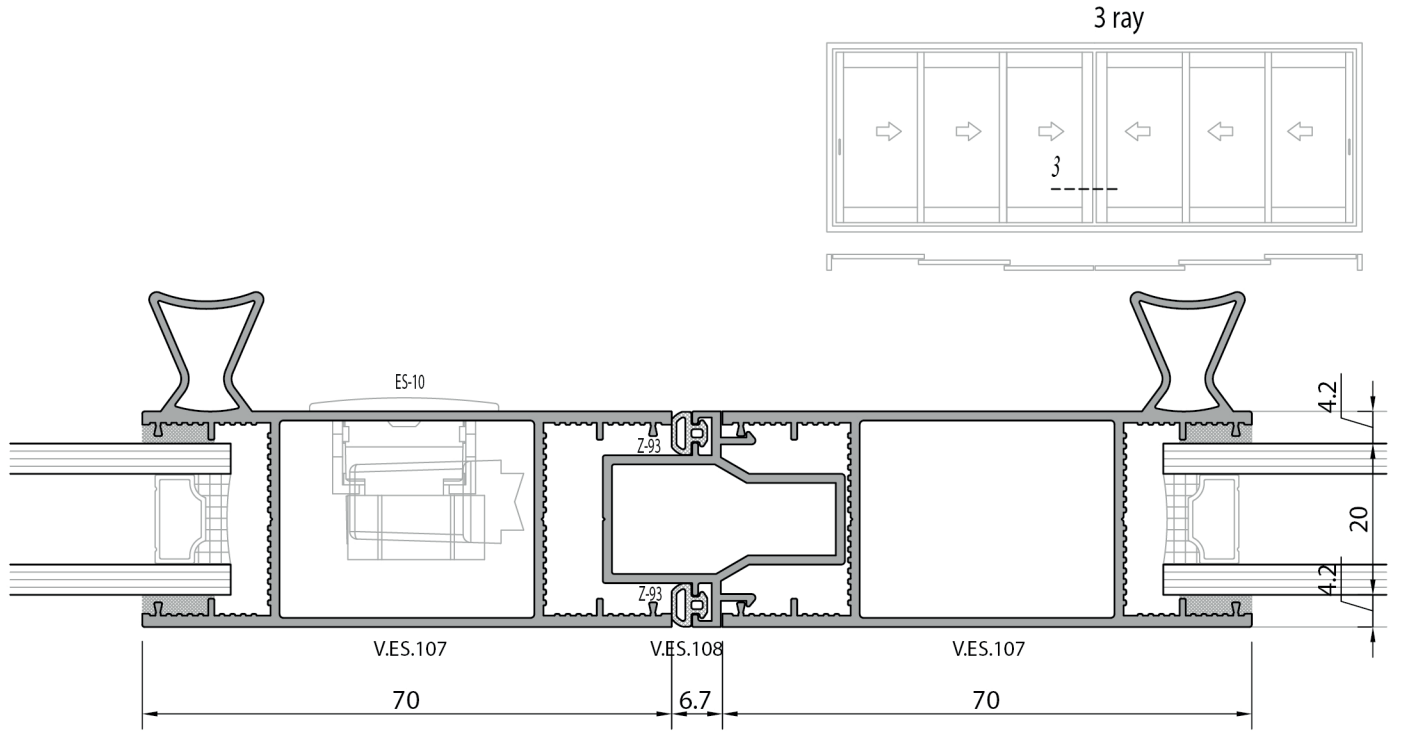

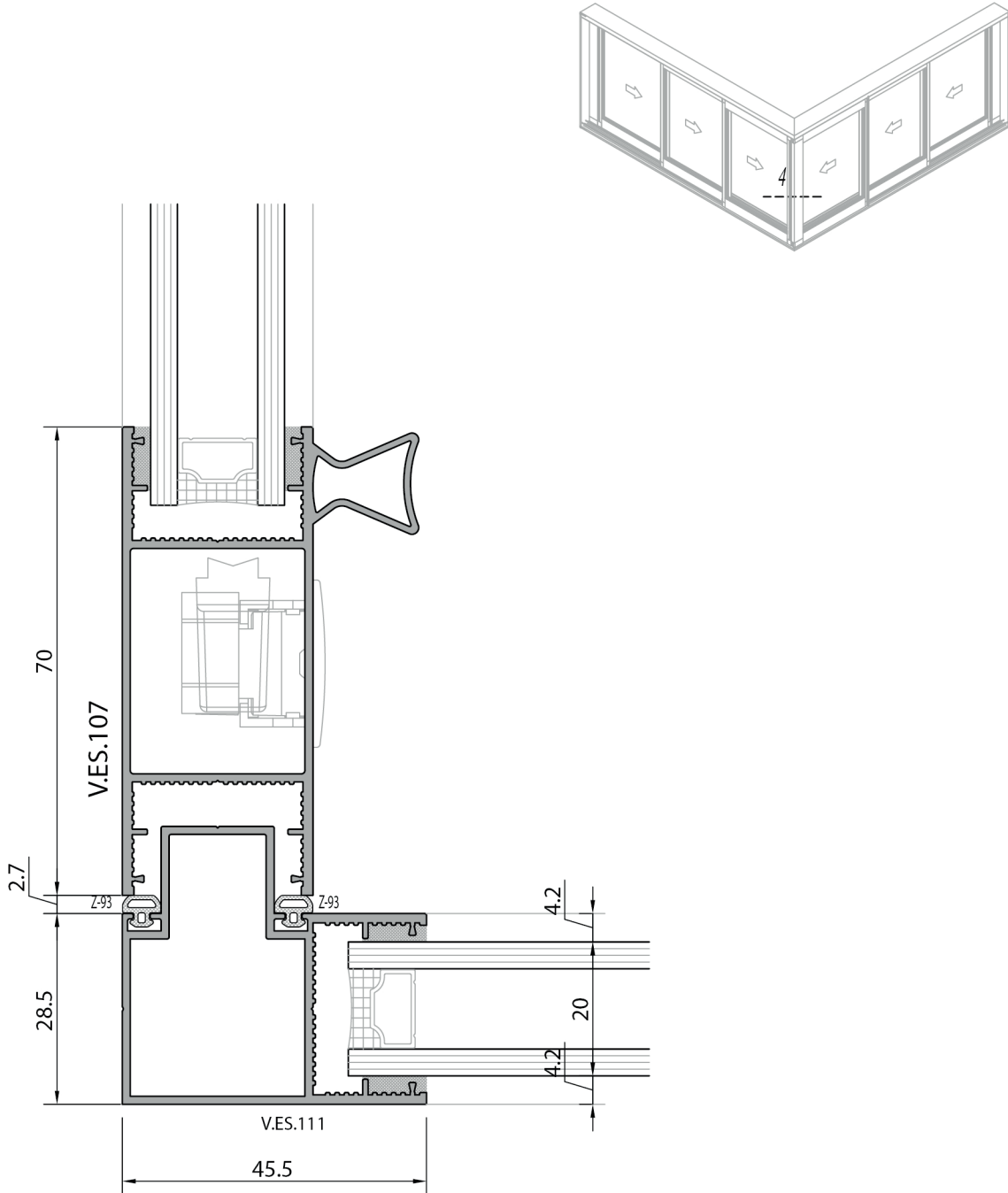

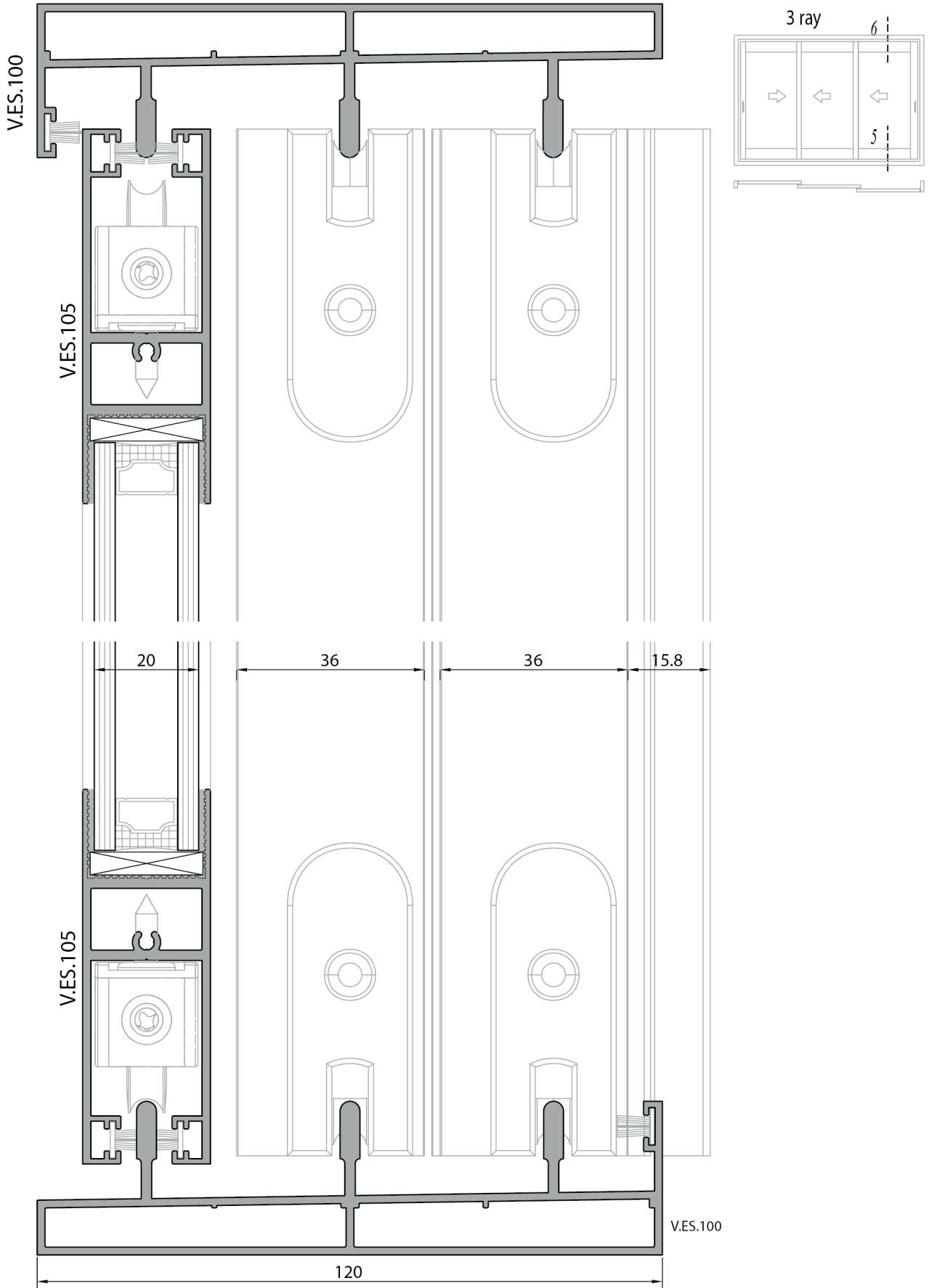

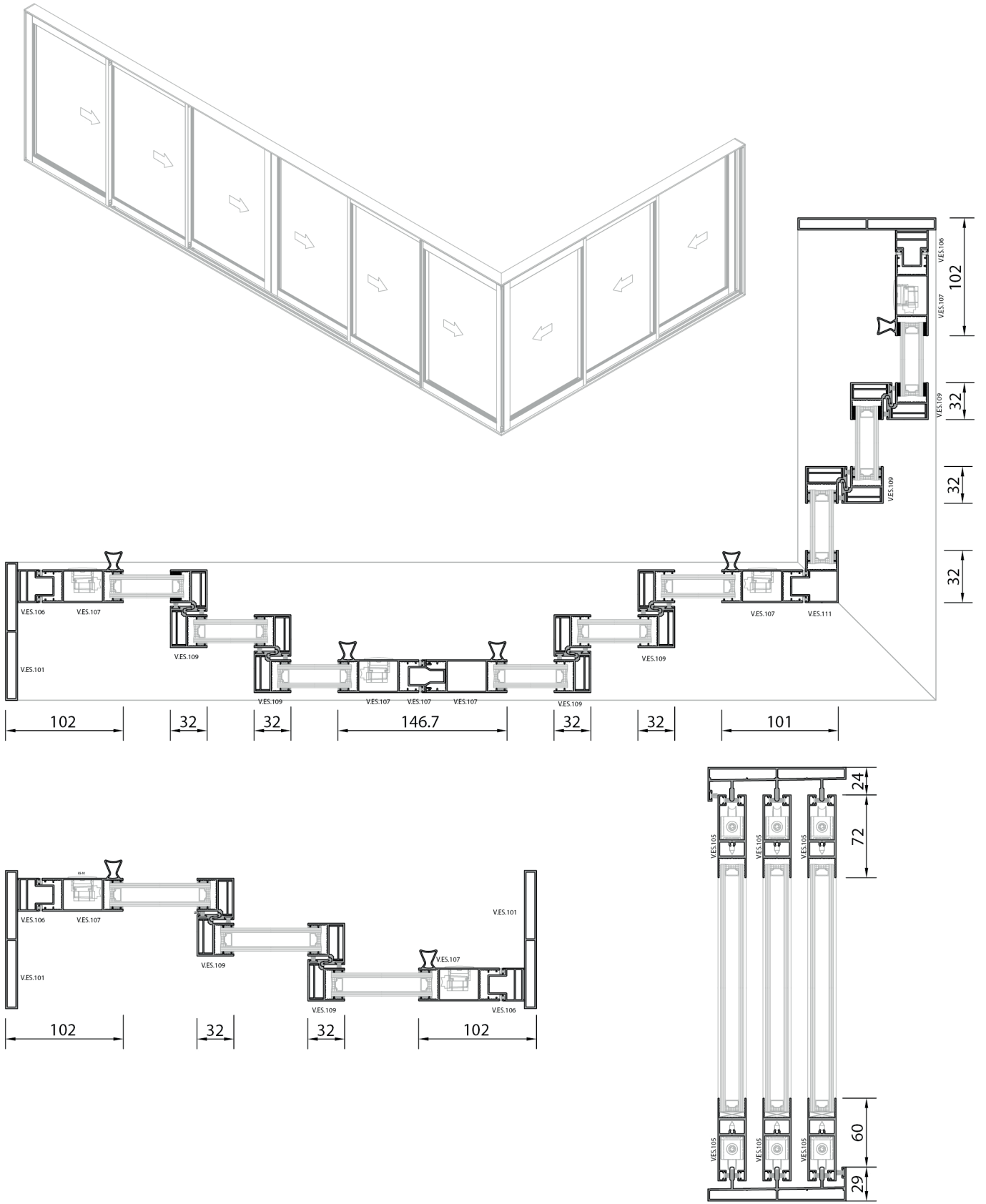

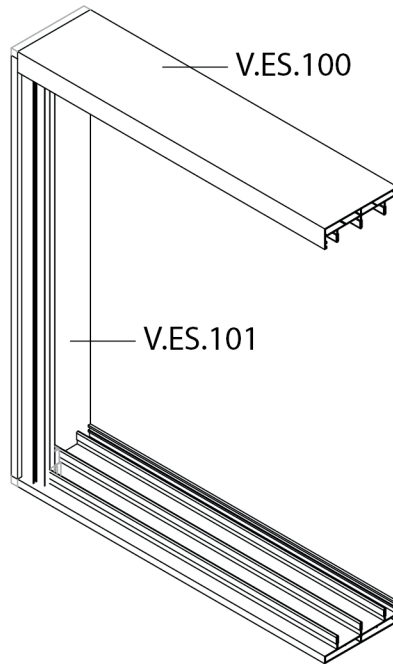
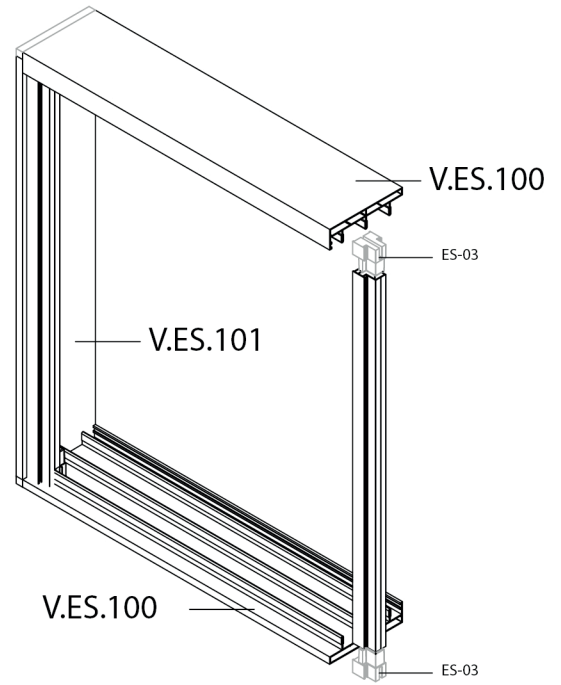
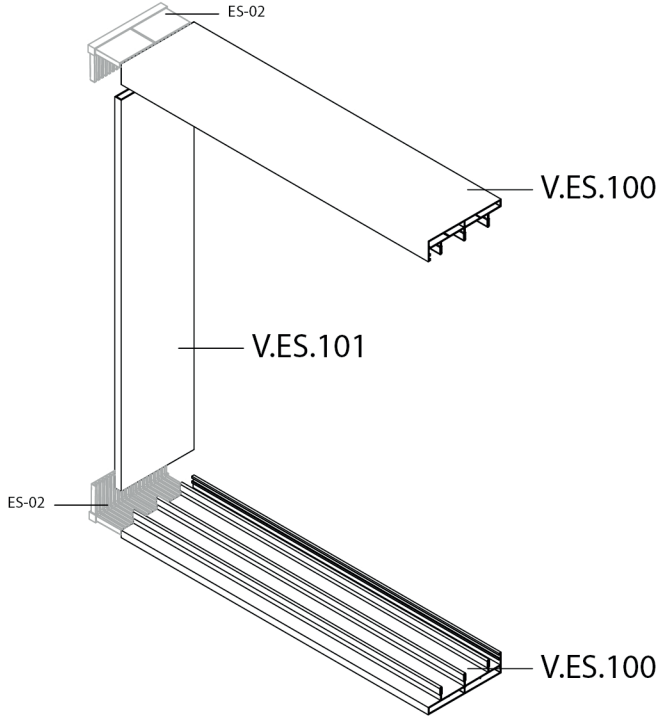

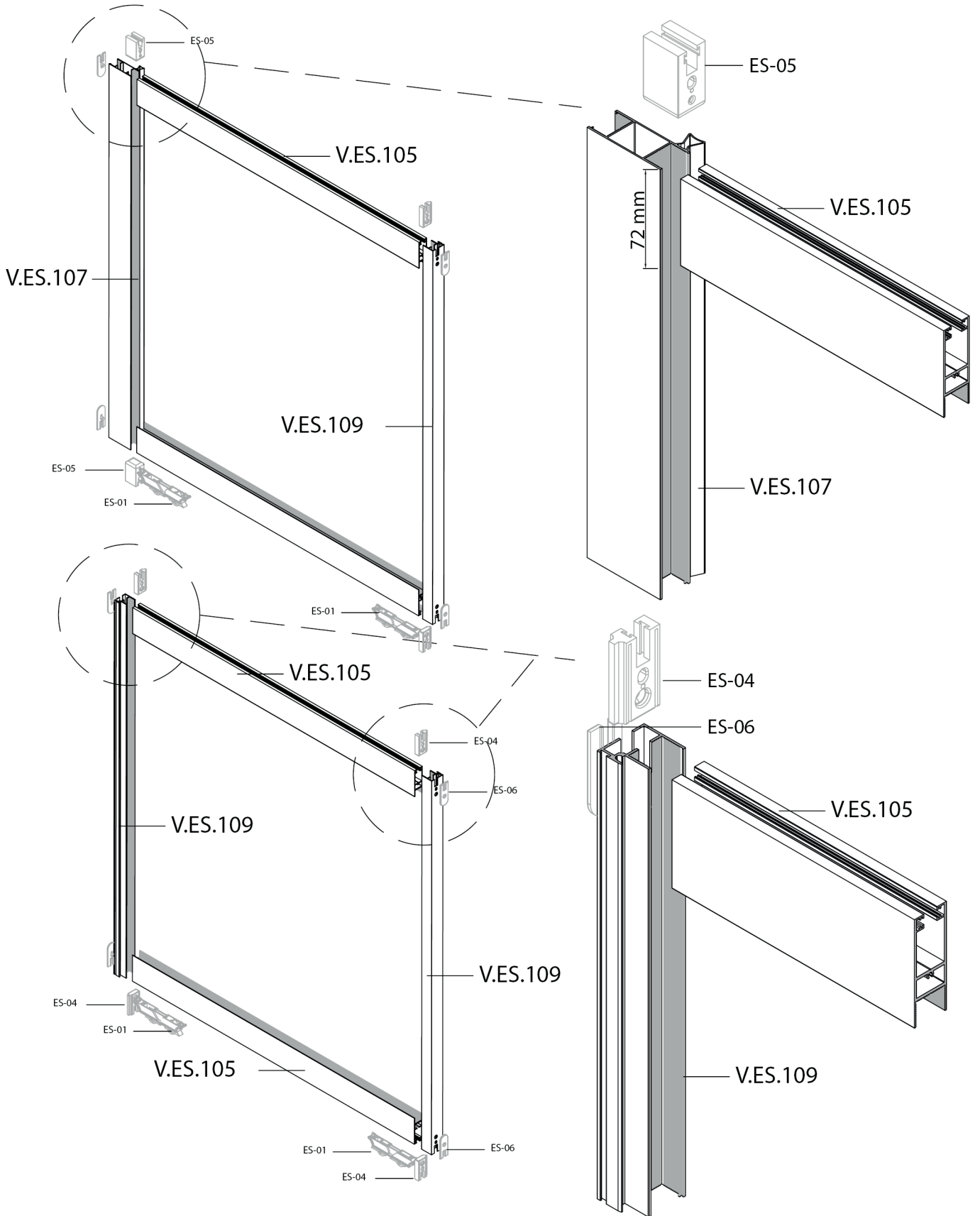

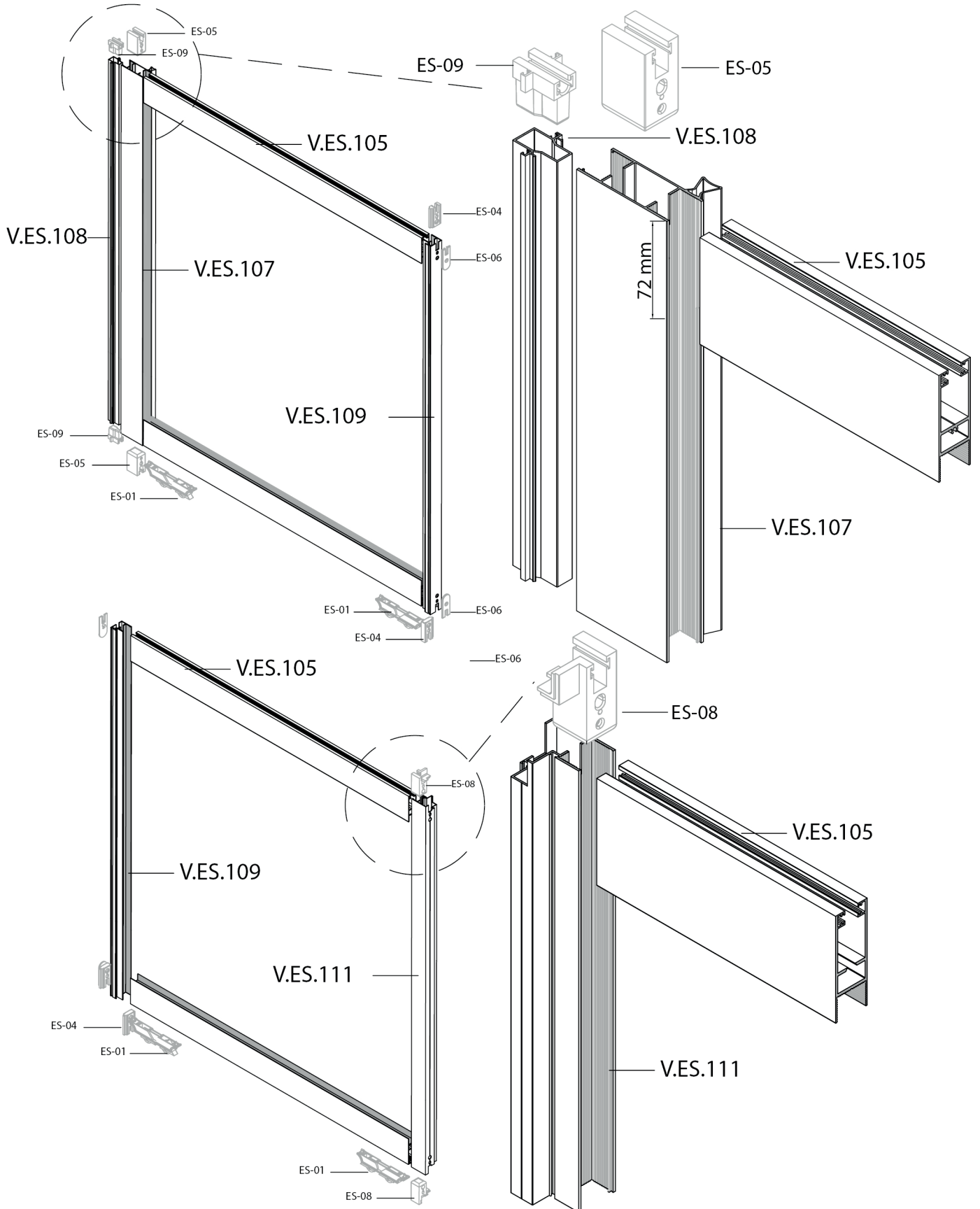

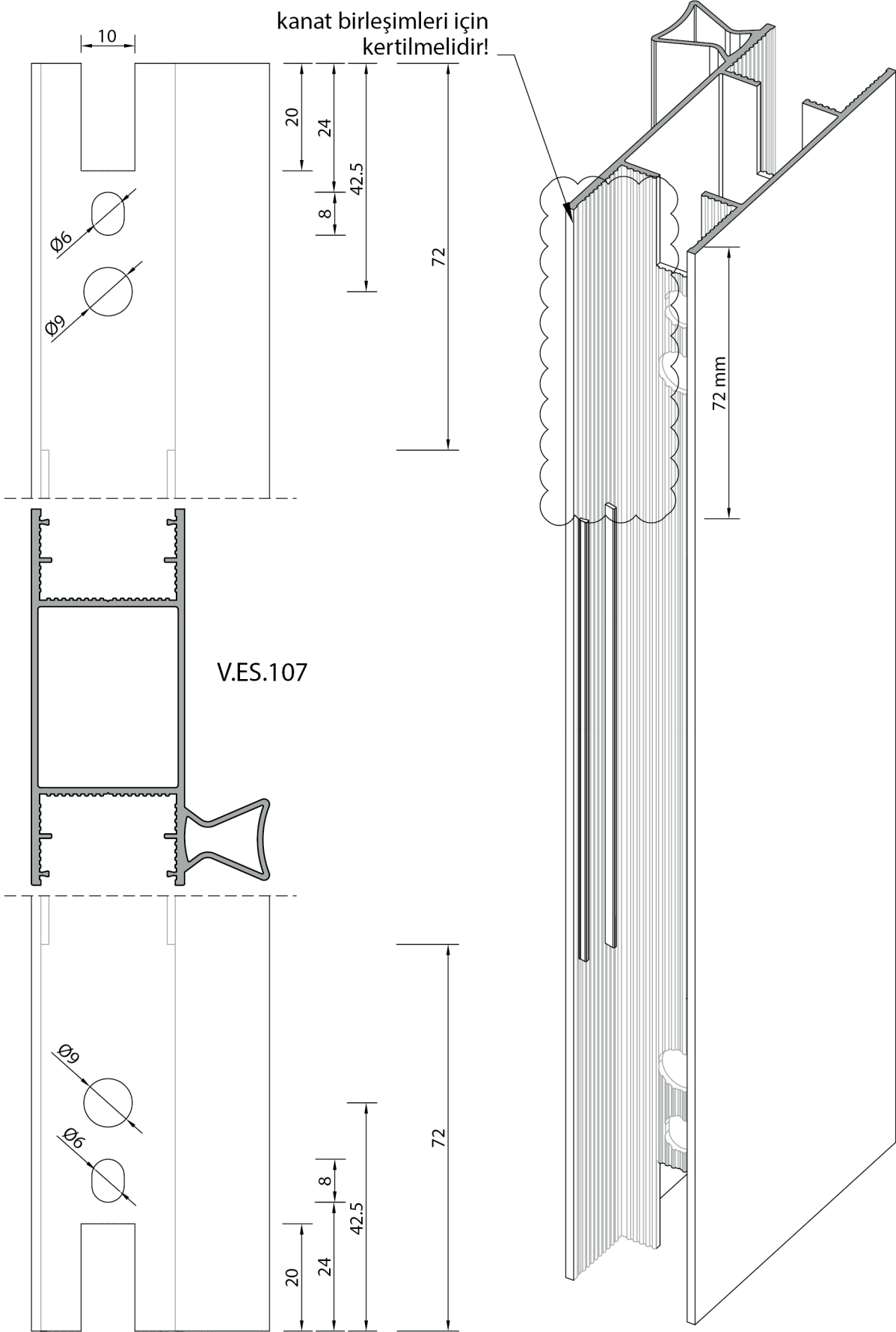

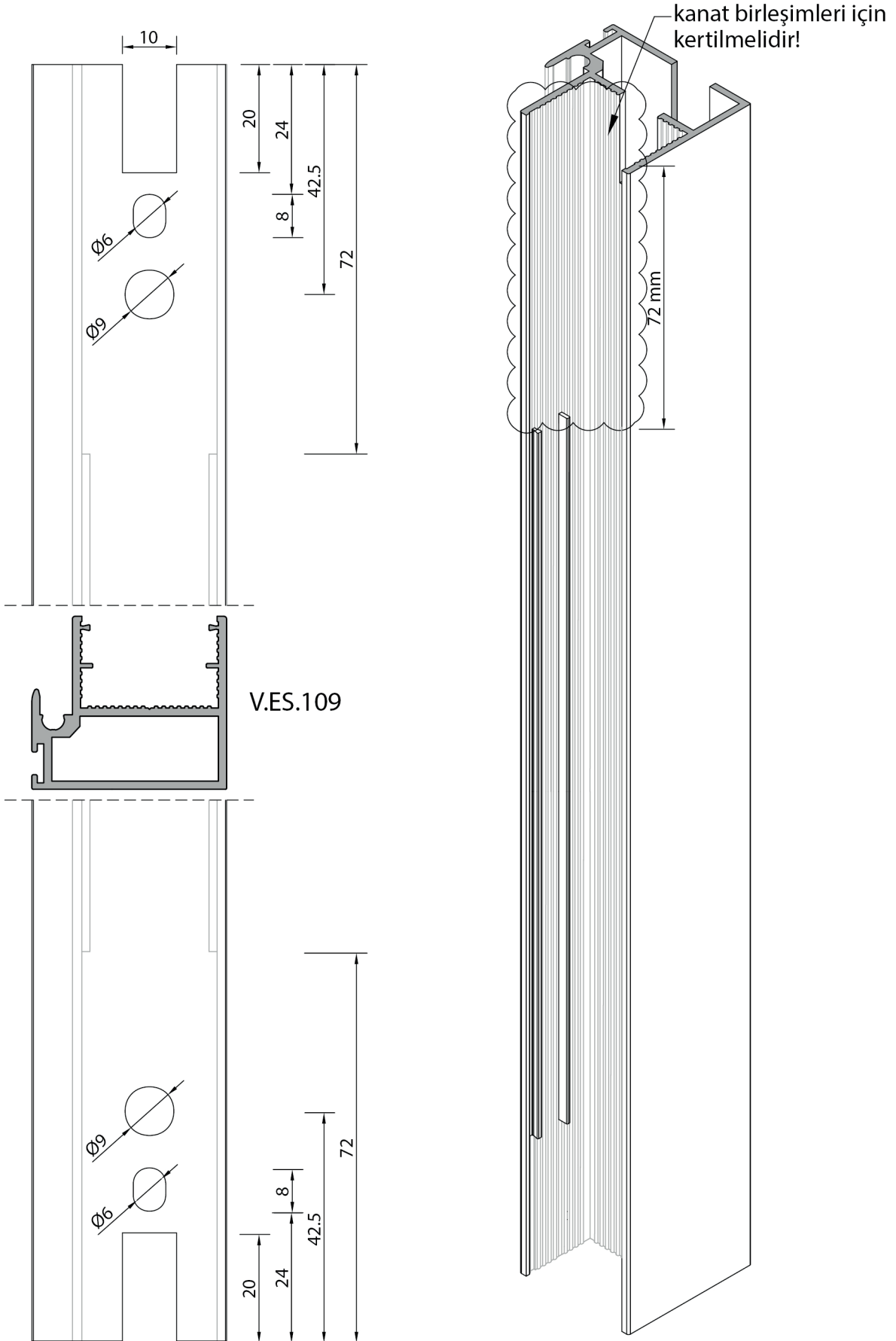

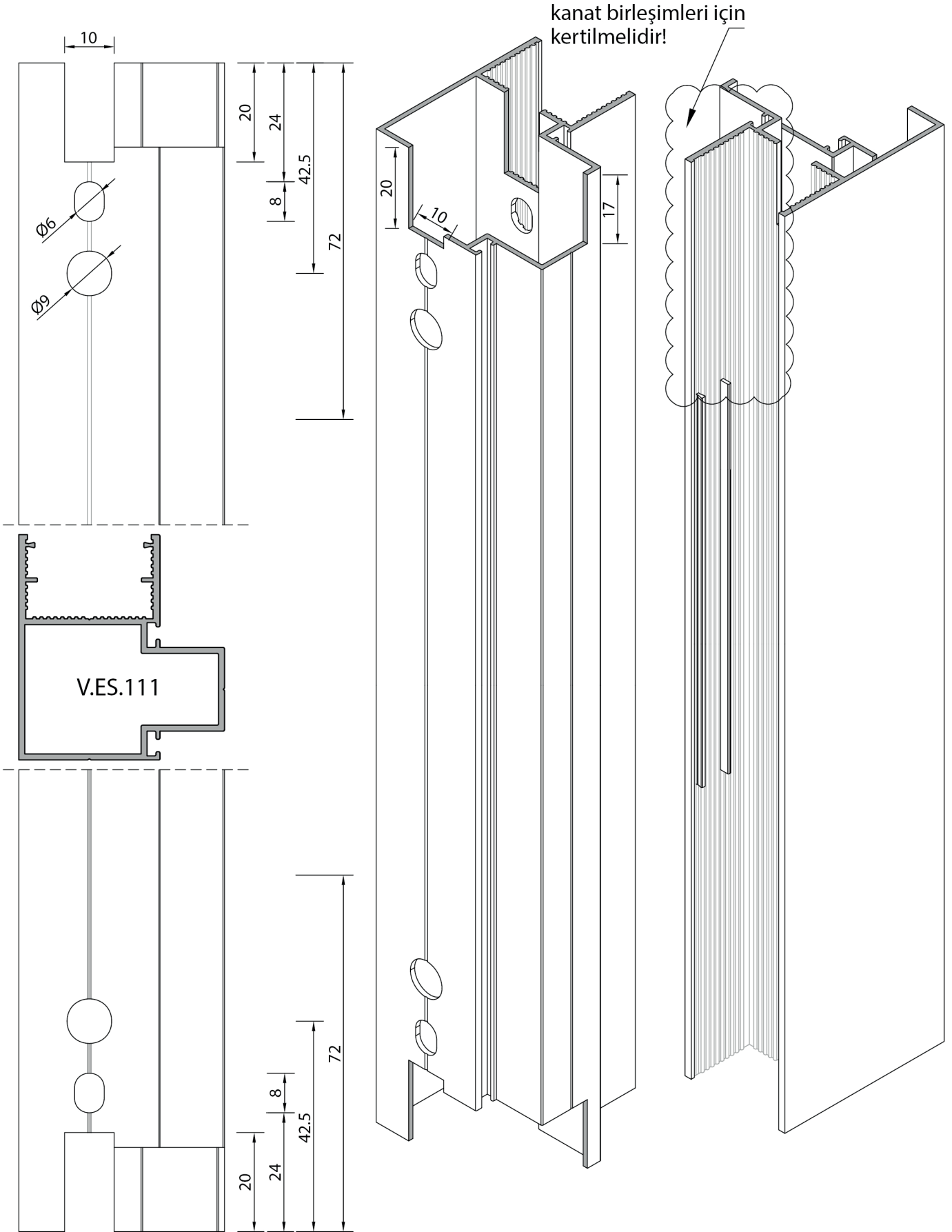

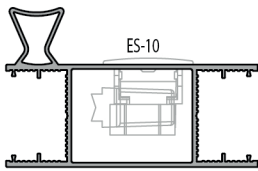
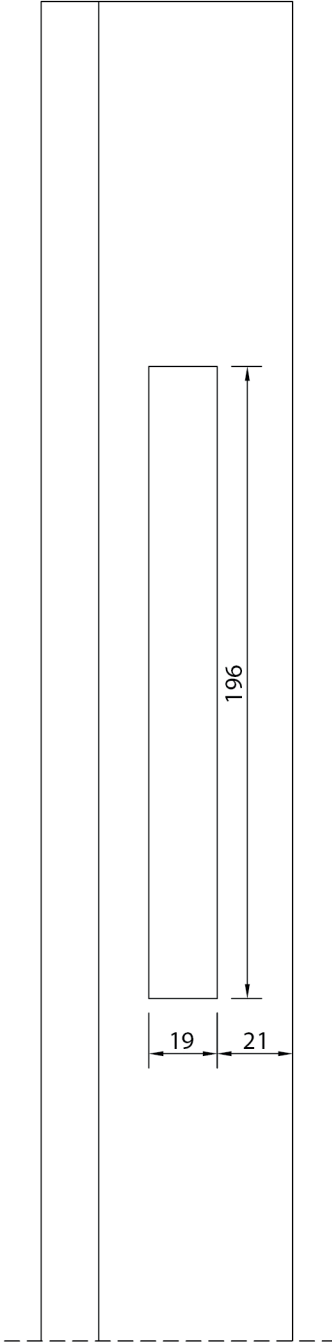

V.ES.107

