

Silinebilir Giyotin Sistem

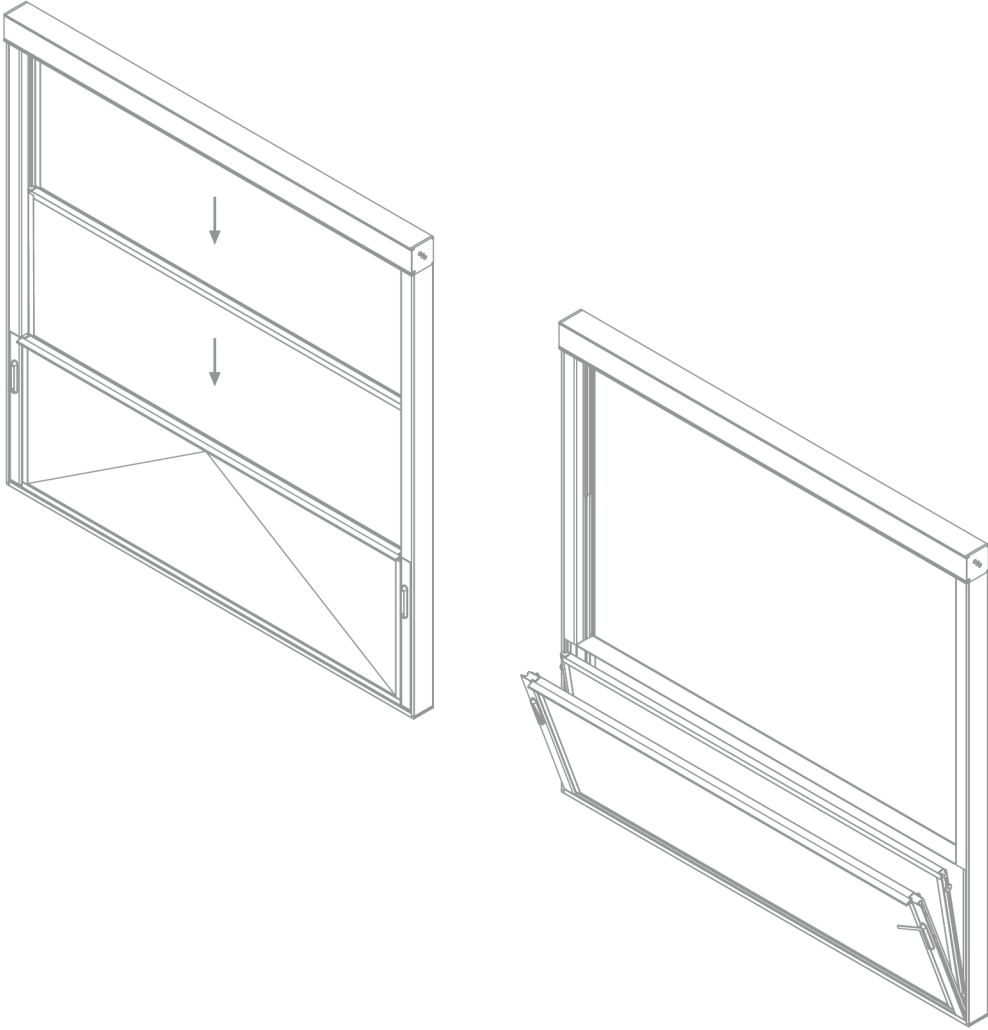

SİLİNEBİLİR GİYOTİN SİSTEM	SİLİNEBİLİR GİYOTİN SİSTEM	V.GY.	V.GY.	201
	<ul style="list-style-type: none">✓ Zincirli ve Kayışlı Mekanizma Alternatifi✓ Cam Özelliği; 8 mm, 10 mm tek cam ve 20 mm ısıcam✓ Max. En : 350 cm / Boy: 300 cm		SİSTEM	PR NO

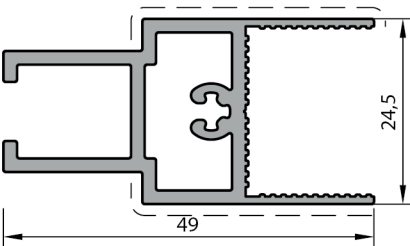
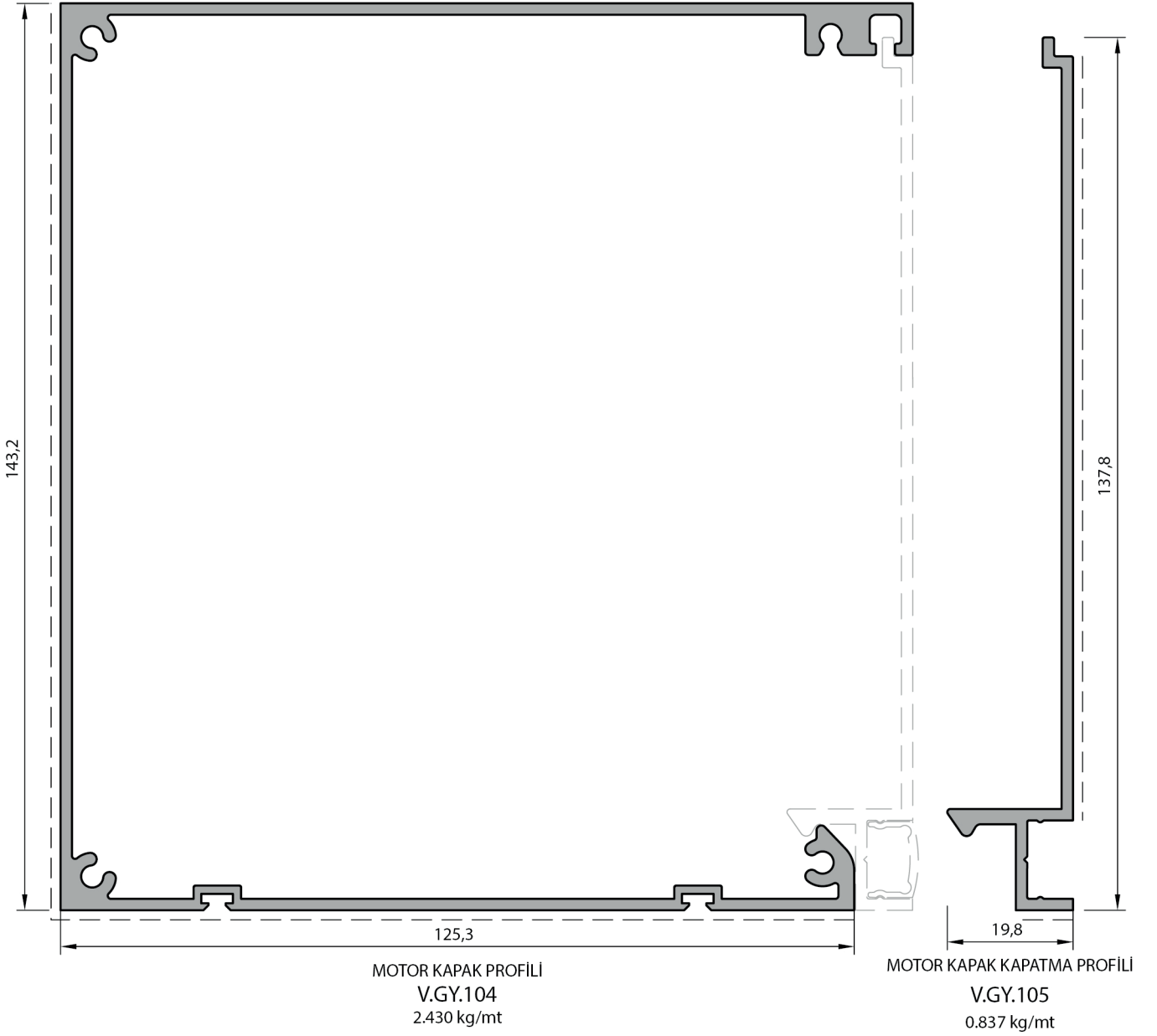

DİKEY BAZA PROFİLİ
V.GY.103
0.706 kg/mt

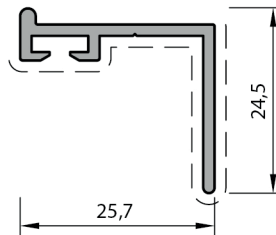

DAMLALIK PROFİLİ
V.GY.111
0.237 kg/mt

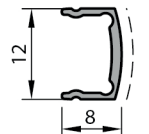

MOTOR KAPAK PROFİLİ
2458
0.065 kg/mt

* Profil ağırlıkları teoriktir. Ağırlık olarak teslimde yapılan tartım geçerlidir.

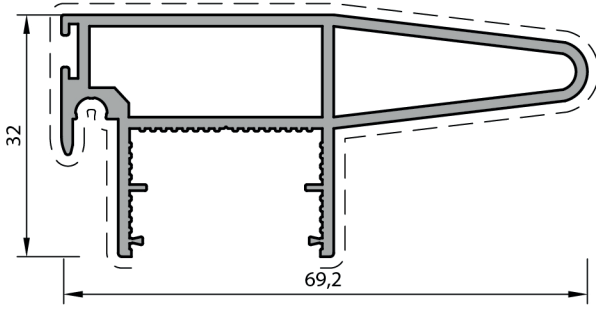

TUTAMAKLI BAZA PROFİLİ

V.GY.206

0.890 kg/mt

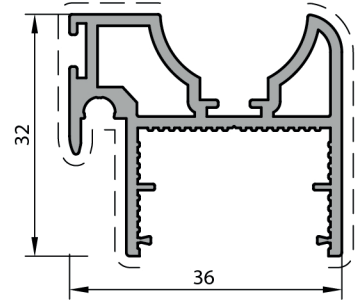

ORTA ALT BAZA PROFİLİ

V.GY.209

0.655 kg/mt

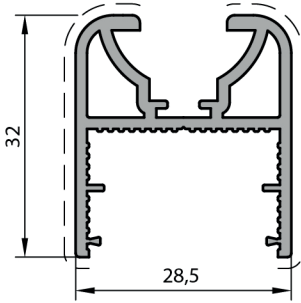

KÜPEŞTE BAZA PROFİLİ

V.GY.207

0.575 kg/mt

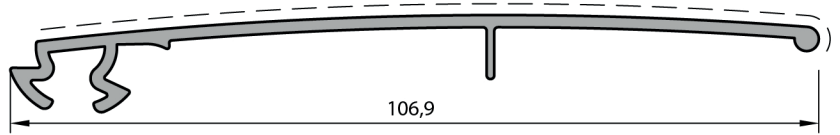

HAREKETLİ KÜPEŞTE PROFİLİ

V.GY.208

0.573 kg/mt

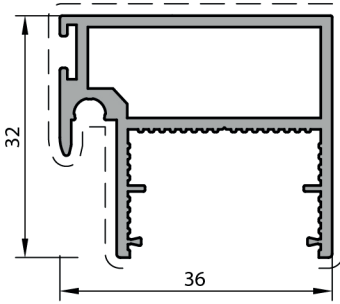

KENET PROFİLİ

V.ES.109

0.606 kg/mt

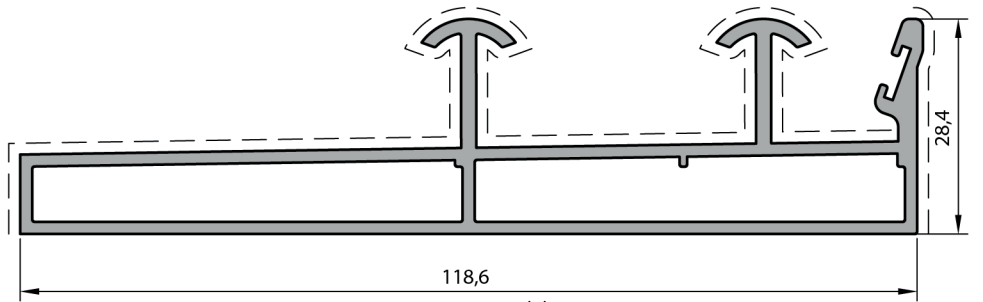

ALT KASA PROFİLİ

V.GY.205

1.561 kg/mt

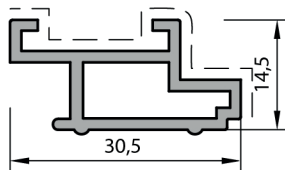

VAŞİSTAS KASA PROFİLİ

V.GY.204

0.342 kg/mt

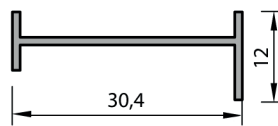

KENET DESTEK PROFİLİ

V.ES.112

0.130 kg/mt

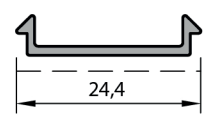

YAN KAPAMA PROFİLİ

V.GY.110

0.100 kg/mt

* Profil ağırlıkları teoriktir. Ağırlık olarak teslimde yapılan tartım geçerlidir.

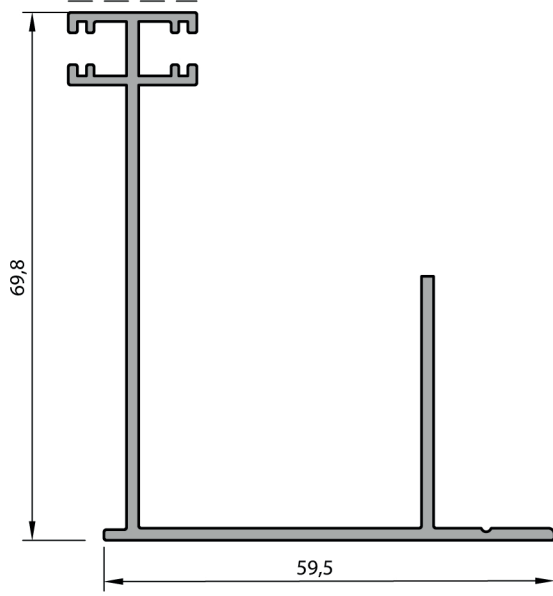

KENET DESTEK PROFİLİ

V.GY.201
0.830 kg/mt

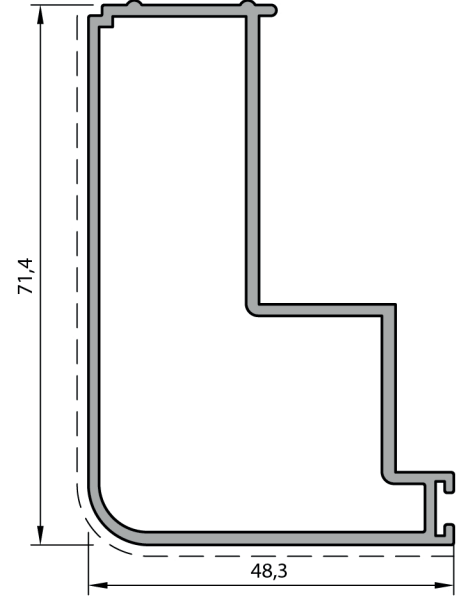

KANAT TAMAMLAYICI PROFİLİ

V.GY.202
0.993 kg/mt

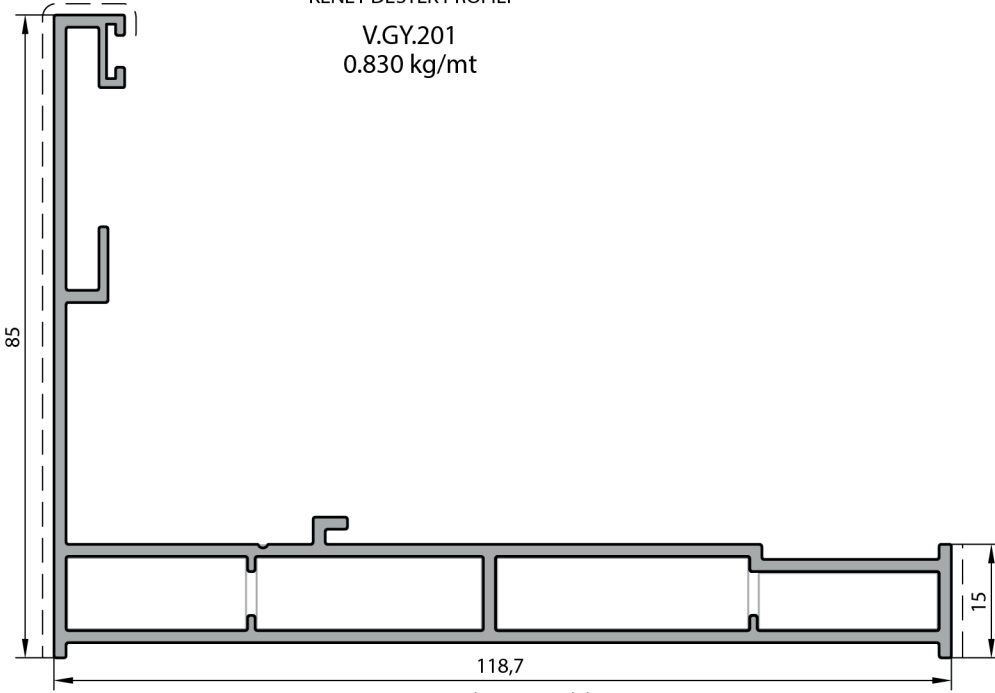

ANA DİKME PROFİLİ

V.GY.101
1.650 kg/mt

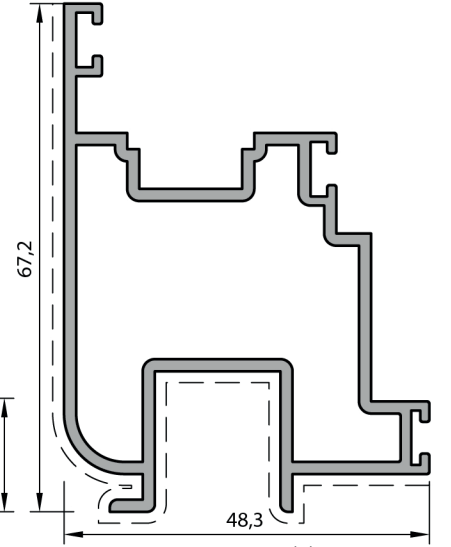

KANAT PROFİLİ

V.GY.203
1.122 kg/mt

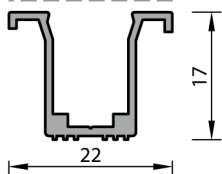

10 MM CAM ÇİTA PROFİLİ
V.ES.103
0.174 kg/mt

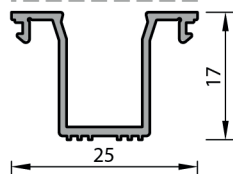

10 MM CAM ÇİTA PROFİLİ
V.ES.104
0.176 kg/mt

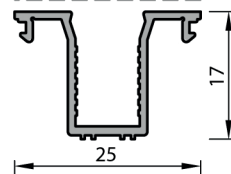



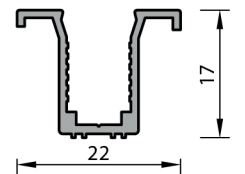





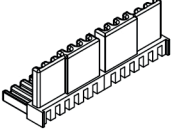
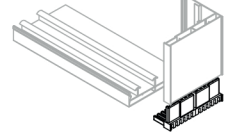
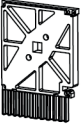
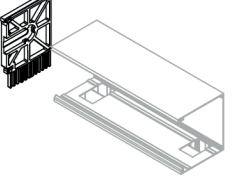
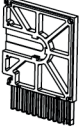
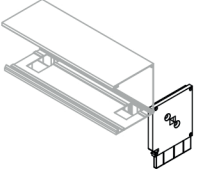

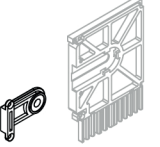
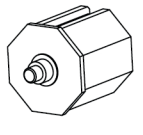
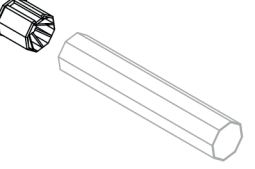
8 MM CAM ÇİTA PROFİLİ
V.ES.115
0.178 kg/mt

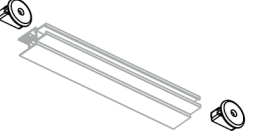
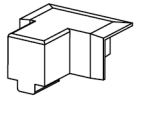
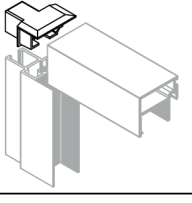
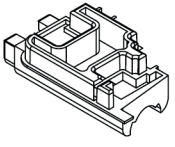
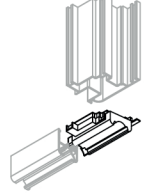
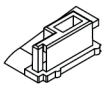
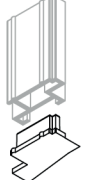

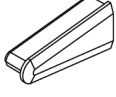
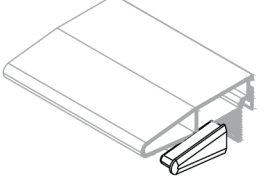
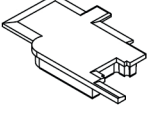
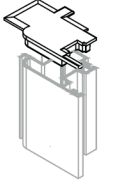
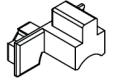
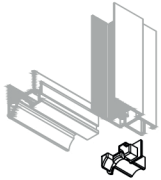
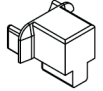
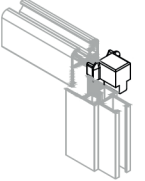
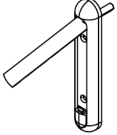





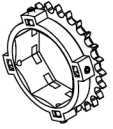
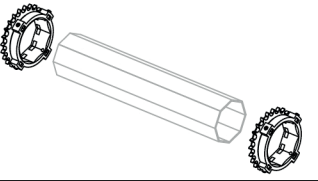
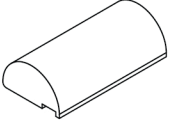
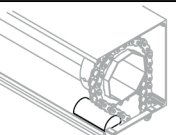

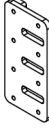

8 MM CAM ÇİTA PROFİLİ
V.ES.116
0.169 kg/mt

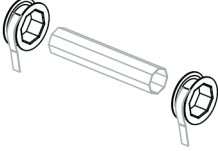
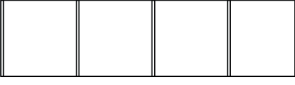
* Profil ağırlıkları teoriktir. Ağırlık olarak teslimde yapılan tartım geçerlidir.

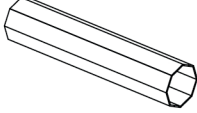
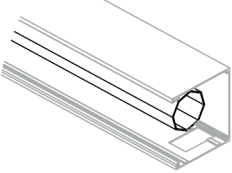
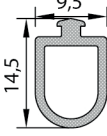
KOD	ŞEKİL	TANIM	PAKET METRAJİ	KULLANIM YERİ
GY-01		Kasa Köşe Birleştirme Takozu	2	
GY-02		Motor Tarafı Kapak	1	
GY-03		Boru Başı Kapak	1	
GY-04		Rulman Yatağı	1	
GY-05		Boru Başı Alüminyum	1	
GY-07		Merkezi Takoz	8	
GY-08		Kenetli Baza Kapak	2L+2R	
GY-19		Vasistas Alt Takoz	1L+1R	
GY-20		Vasistas Alt Kasa Takoz	1L+1R	

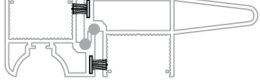
KOD	ŞEKİL	TANIM	PAKET METRAJİ	KULLANIM YERİ
GY-21		Tutamaklı Baza Kapak	2	
GY-22		Vasistas Üst Kapak	1L+1R	
GY-23		Orta Vasistas Alt Kasa Takoz	1L+1R	
GY-24		Küpeşte Takoz	2	
GY-25		Vasistas Kol	2	
GY-26		Vasistas Makas	2	
GY-27		İspanyolet kilit	2	
GY-11		Zincir Dişlisi	2	
GY-13		Zincir Yönlendirici	2	

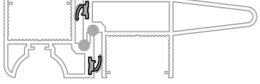
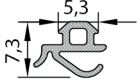
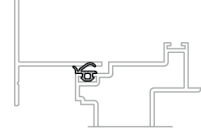
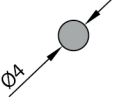
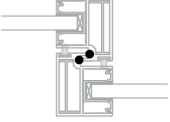
KOD	ŞEKİL	TANIM	PAKET METRAJİ	KULLANIM YERİ
GY-14		Zincir 2,5 m	2	
GY-15		Zincir ve Kayış Tutucu	2	
GY-16		Kayış Kasnağı	2	
GY-17		Kayış 2,5 m	2	
GY-18		Motor Borusu	1	
Z-94		Epdm Kapak Baskı Fiteli	65 gr/m 153 m	
LS55520		Fırça Fiteli	400 m/pk	
ZF-1		Flock Fiteli	200 m/pk	
Z-63		Epdm Kanat Baskı Fiteli	40 gr/m 200 m	
W55.511		Epdm Kenet Fiteli	16 gr/m 609	

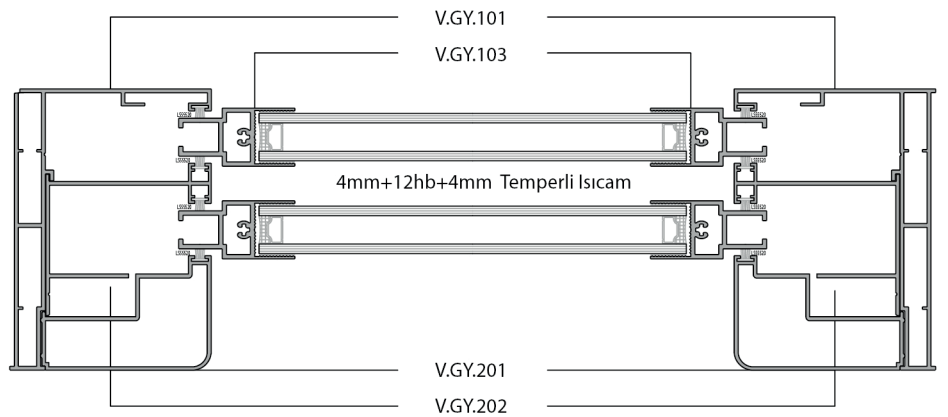
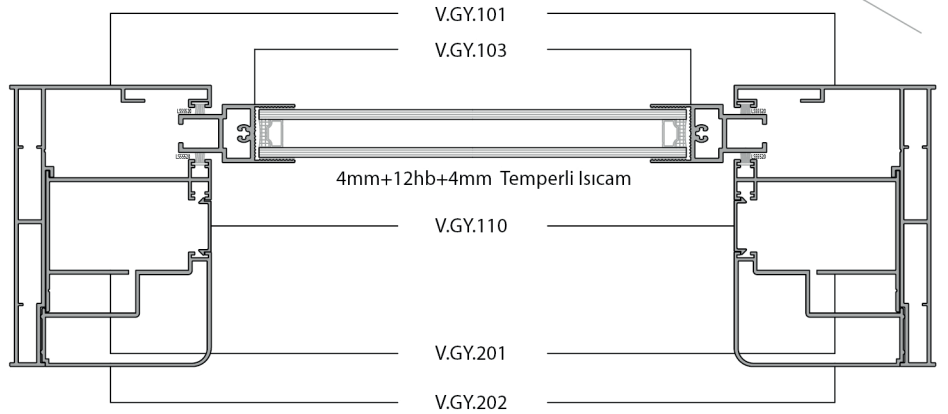
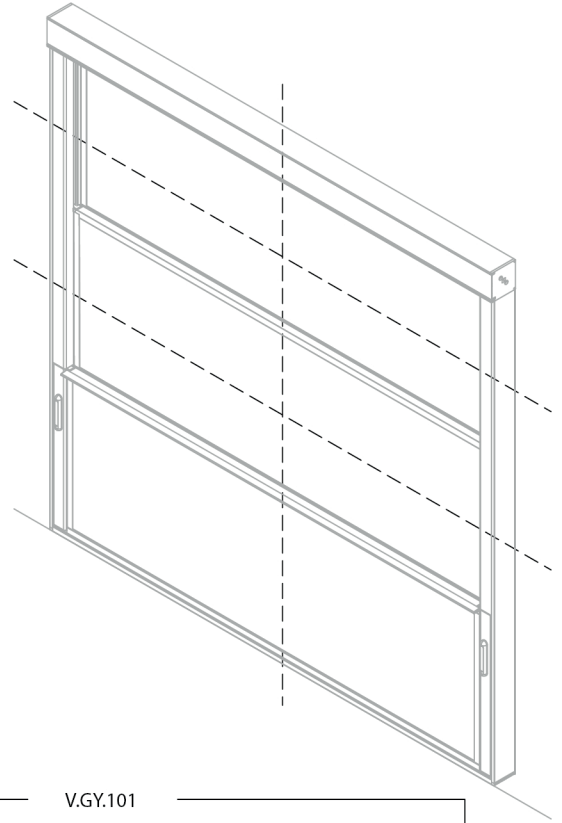
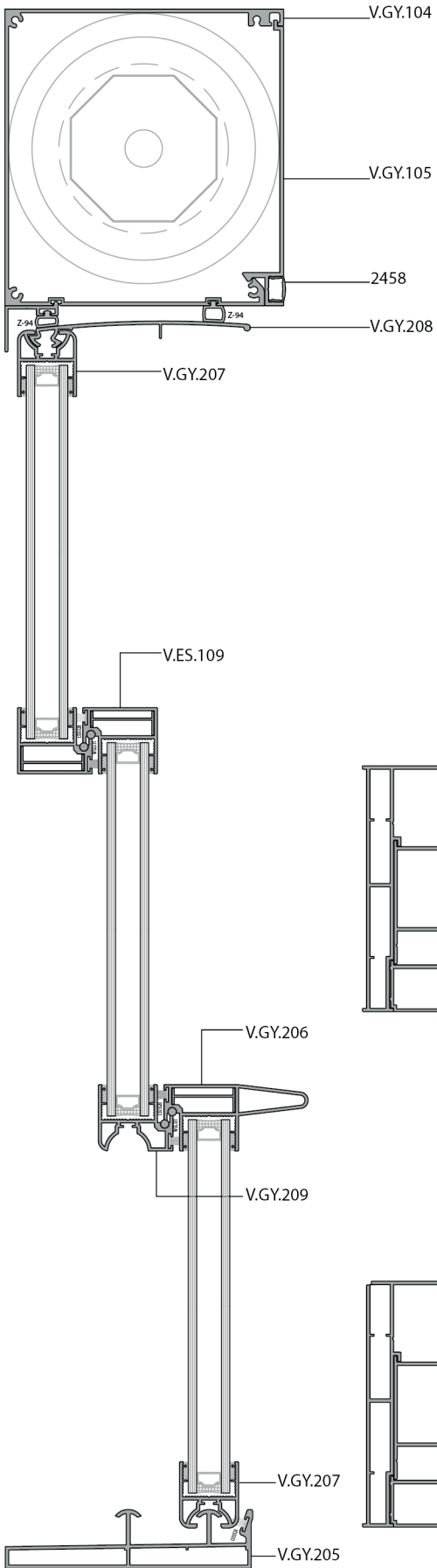

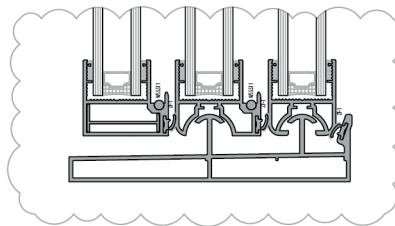
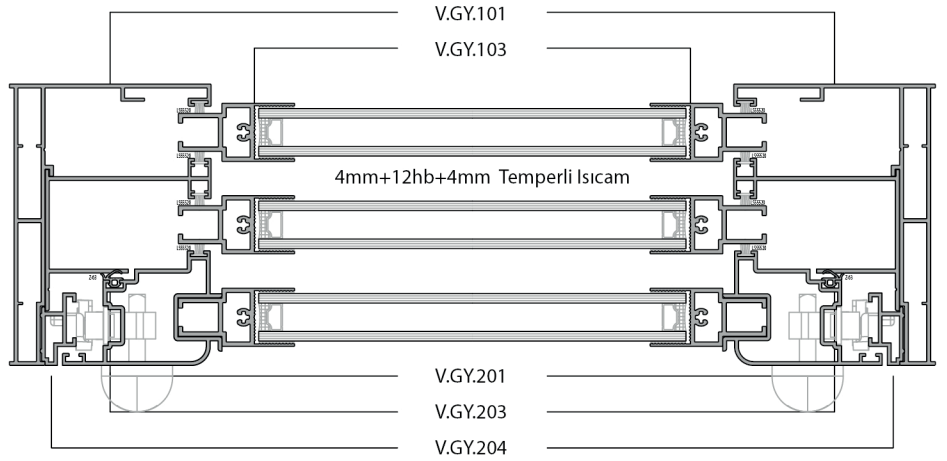
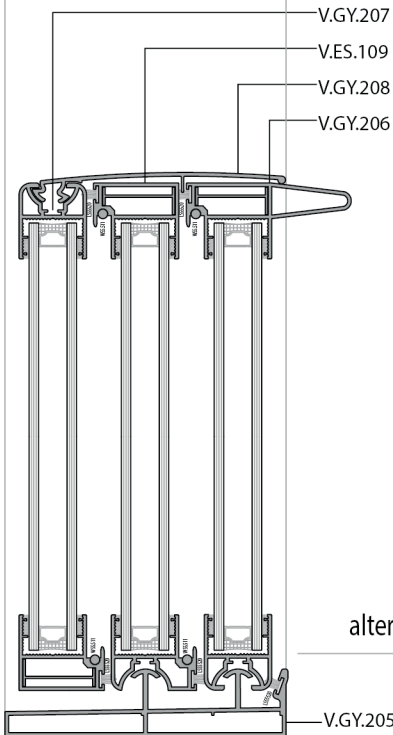
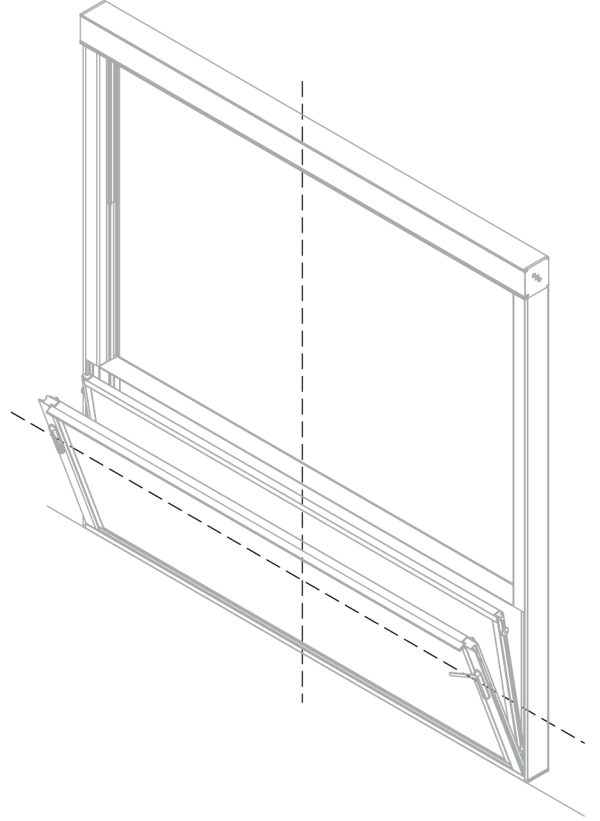
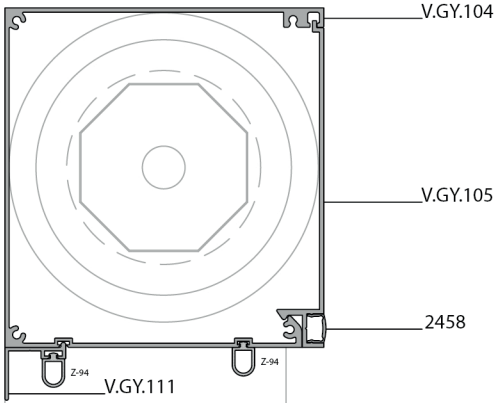

AÇILIR PANEL MONTAJ

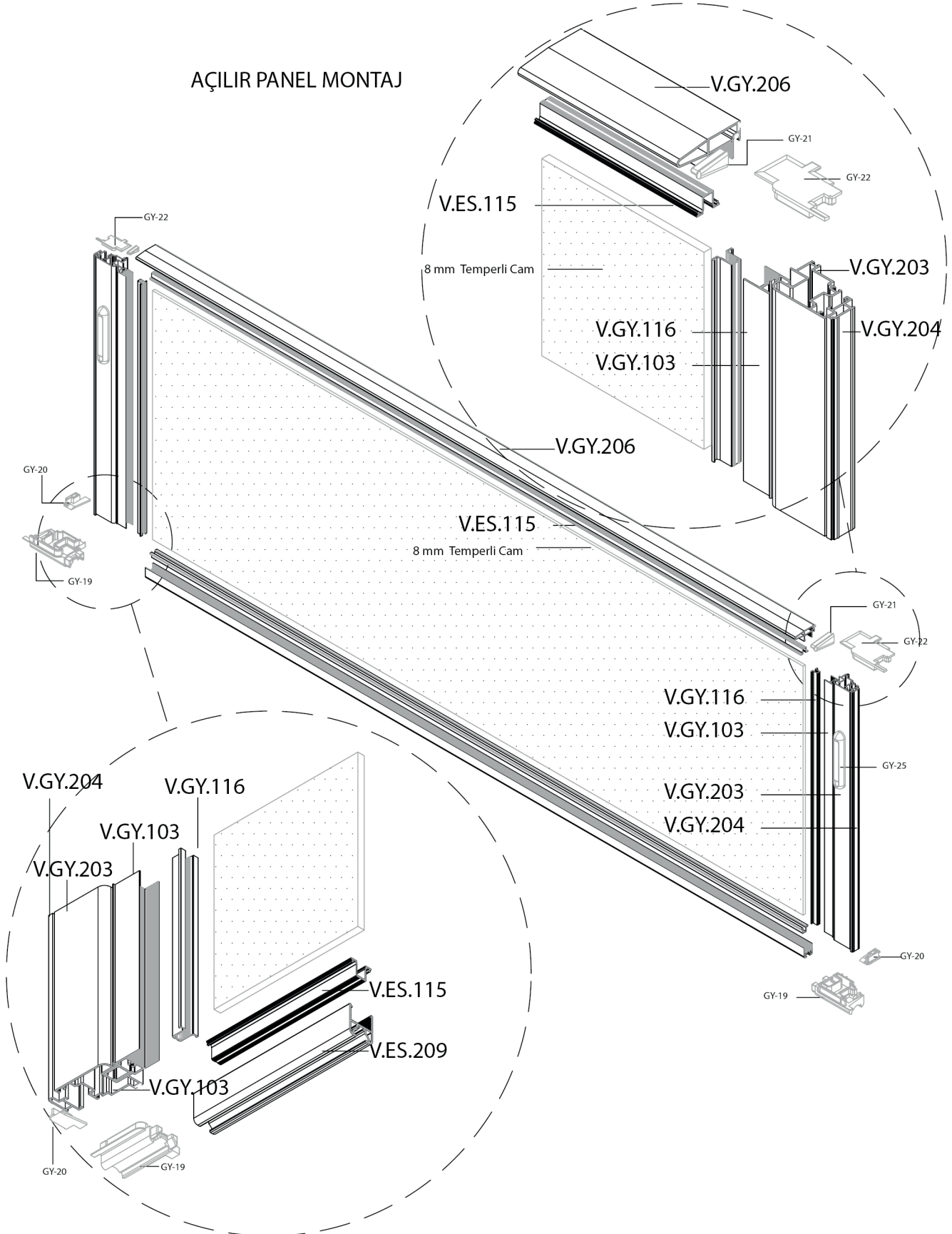

ORTA PANEL MONTAJ

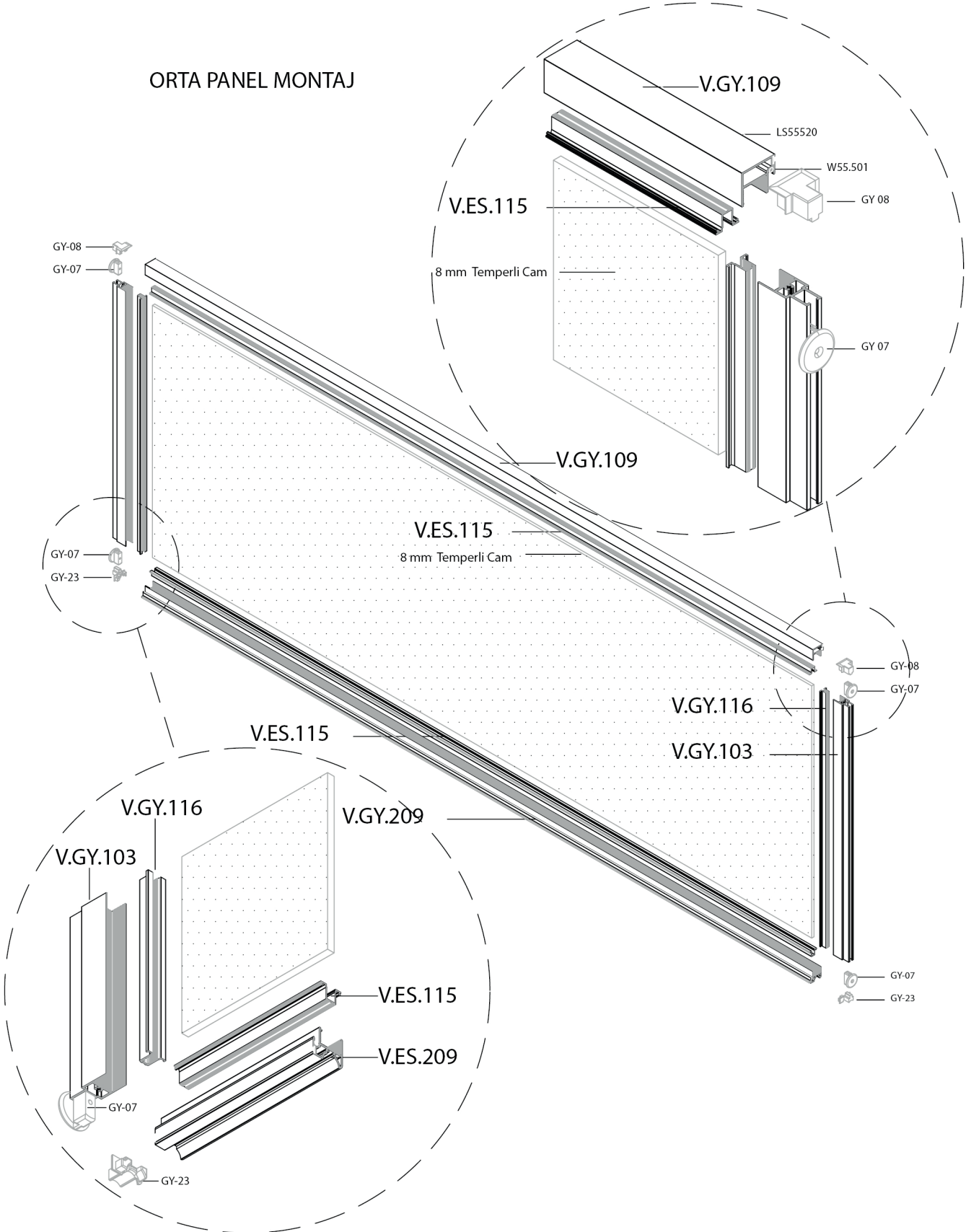

DIŞ PANEL MONTAJ

